

TECHNICAL INFORMATION
HCC 2
Home ventilation unit for suspended ceiling



Dantherm[®]
CONTROL YOUR CLIMATE

HCC 2 Home ventilation

1	GENERAL DESCRIPTION	4
2	CONTROL	9
3	TECHNICAL DATA	10
4	ACCESSORIES	13



GENERAL DESCRIPTION

The HCC 2 home ventilation unit is primarily designed for new constructions or retrofitting into multiple apartment buildings. The outer dimensions and design allow easy installation into a suspended ceiling or onto a wall, hidden inside a closet.

The unit is supplied as a basic unit, with the option of fitting a wide range of accessories into the unit, thus extending the comfort and reducing the energy consumption.

The home ventilation unit is equipped with a highly efficient plastic counter-flow heat exchanger, which is optimised to a high efficiency level. This, combined with a low headroom, results in a very slim ventilation unit, easily hidden in a suspended ceiling, together with the duct system.

Key features

- ▶ High efficiency heat recovery – up to 94%
- ▶ EC fan motors with low energy consumption (SFP data)
- ▶ Only 300 mm installation headroom height is required.
- ▶ Time controlled ventilation level, based on 11 different built in pre-programmed week programs. This reduces power consumption in periods with low ventilation demands.
- ▶ Summer cooling mode, in which the supply fan is stopped, and any open window will supply colder outside air, decreasing the room temperature. Summer cooling mode requires a wired control HCP 10 (accessory).
- ▶ Fireplace mode, creating a momentary inside overpressure, to enhance chimney functionality.
- ▶ Easy-to-install and commissioning solution with built in air measure ports, for easy balancing with PC-Tool.
- ▶ Electronically left / right fan direction switching, allowing same unit type to adapt any physical installation requirements, regardless of ceiling and wall selection.
- ▶ Demand controlled ventilation (accessory)
- ▶ Highly customizable unit, by adding a high variety of internal as well as external accessories. See more details in the chapter "Accessories".
- ▶ TCP ModBus connection, for inter-operation with Building Management System

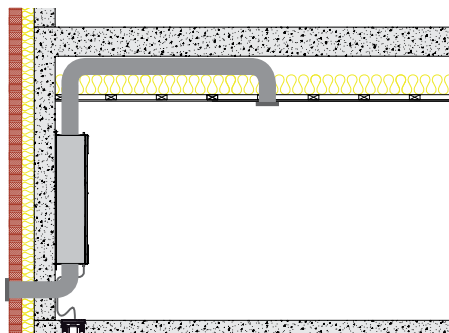

HCC 2 on wall

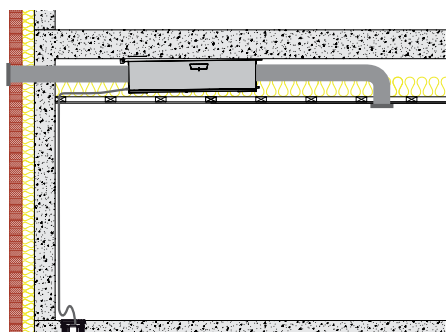

HCC 2 in suspended ceiling

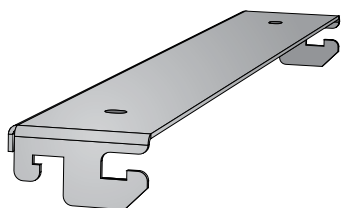

Universal mounting bracket

HCC 2 enclosure

The unit enclosure is designed to fit low headroom suspended ceilings, and yet still with easy service access. The outer surface is 0.8 mm Aluzink powder coated sheet, painted white in RAL 9010, with two external lids covering the two filter slots.

All inside air paths and insulation, is made of EPS (Polystyrene). This has a high insulation level, and good air tightness. This insulation thickness permits location of the units in spaces with temperatures down to +12°C.

Installation parts

The enclosed mounting bracket is designed to conduct a safe installation process, and is suitable for both wall and ceiling installation.

The mounting bracket will:

- ▶ Tilt the unit slightly towards the drainage spigot, ensuring correct drainage of any condensed water inside the unit when used for ceiling installation.
- ▶ Offer a easy wall installation process

Mirroring all duct connections

The air flow direction can be electronically swapped, providing ability to route the connected ducts, either to the right or to the left. This means that the supply air duct connections can be either to the right or to the left hand side of the unit. (Supply air and extract air duct connections always towards the inside of the house and outside air and exhaust air ducts always towards the outside of the house).

All electrical cables can be connected from either the left or the right hand side, regardless of fan direction.

Function

The unit will ventilate residential homes by extracting the inside humid air, and replacing it with fresh outside air, that has been heated with the extracted air's heat energy. This results in residential ventilation with a low energy consumption.

The air volume can be controlled by:

- ▶ Selecting a fixed fan speed between 0-4.
- ▶ Demand mode: By fitting the HCC 2 unit with optional VOC or RH sensors (accessory) the fan speed is automatically adjusted to the actual demand, determined by the quality and the relative humidity of the extracted air.
- ▶ 11 different week programs, where the fan speed will increase or decrease according to an hourly time schedule.

When very humid inside air is extracted, the humidity will condense inside the heat exchanger, and be collected by the embedded drip tray. This water is to be drained from the unit with a drain hose, and disposed of to a nearby drainage.

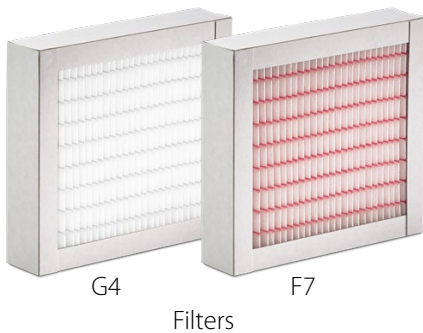

Filters

The HCC 2 home ventilation unit uses 50 mm G4 compact filters as standard for both supply air and extract air. This will cater for the majority of air cleaning needs. The advantage of compact filters is that they have a considerably larger filter surface area than fibrous filters and small bag-filters. The filter thus works for longer and under normal conditions it will not need changing more often than once or twice a year.

If necessary, F7 filters (pollen filters) are available as accessories, which ensure that allergens do not enter the home through the ventilation system.

Fans

The HCC 2 home ventilation unit is equipped with the latest EC (Electromagnetic Commutation) fan motor technology. I.e., use of modern motors and fan rotors offering the very best in air technology and electrical efficiency. Thanks to the EC technology the bearings are the only moving parts to produce resistance and therefore the lifetime of these fans is approx. 10 years. The fans are connected to the controller of the fan unit and powered by 230 V. Stepless fan speed controlled by a 0-10 volt signal.

Heat exchanger

Heat recovery takes place in a highly efficient counterflow heat exchanger made of plastic material offering optimum efficiency with the lowest possible loss of pressure. The heat exchanger is placed with upright standing lamella, which ensure correct self-drainage by gravity, resulting in a very hygienic solution.

Frost protection of the heat exchanger:

The intelligent control system of the HCC systems ensures that the heat exchanger does not ice up in winter.

- ▶ Frost protection is activated if the exhaust air temperature (T4) is $< +2^{\circ}\text{C}$, which will usually occur when the outdoor air temperature (T1) falls below approx. -3°C .
- ▶ When the exhaust temperature (T4) falls to $+2^{\circ}\text{C}$, the system reduces the volume of supply air (T2) so that the final exhaust temperature (T4) is maintained at minimum $+2^{\circ}\text{C}$.
- ▶ If it is particularly cold, the supply air volume will be turned right down to 0 m³/h for short intervals in order to keep the heat exchanger frost-free.
- ▶ If the outdoor air temperature (T1) falls below $< -13^{\circ}\text{C}$ for more than four minutes, the system stops completely for 30 mins. in order to prevent icing up.

In areas where the outdoor temperatures often is lower than -6°C , we recommend to mount pre-heating. In other areas, where the outdoor temperature may fall below -10°C , preheating is a must for obtaining a balanced and reliable solution.

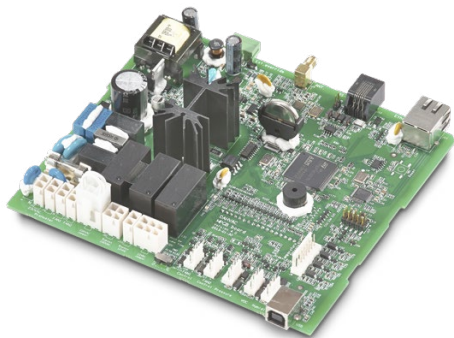

Embedded controller

Controller

The unit's main controller measures and adjusts all parameters continuously in order to maintain a correct ventilation level, with the lowest possible energy consumption. The controller has a wide variety of connections, both for internal accessories as well as for external.

The controller has a wide range of self-test and logging functions, enabling any corrective maintenance specialist, to make quick and efficient corrections if needed.

As the HCC 2 home ventilation unit is designed for hidden installation, the basic unit comes without built in control panel. Please see the chapter "Accessories" for more details about the various control possibilities.

HCC external connections:

The controller offers a wide range of connections, both for internal parts, as well as external.

The following external connections are available:

- ▶ Antenna connection for communicating with the wireless remote control (accessory)
- ▶ RJ 45 LAN connection, offering 2 way TCP ModBus data for integration with building management system.
- ▶ RS-485 ModBus for HAC 2 accessory extension module and connection of wired control H CP10
- ▶ 2 pcs. digital inputs, with several programmable options through PC-TOOL.
- ▶ Pre-heater output for connecting the Dantherm pre-heater (accessory)

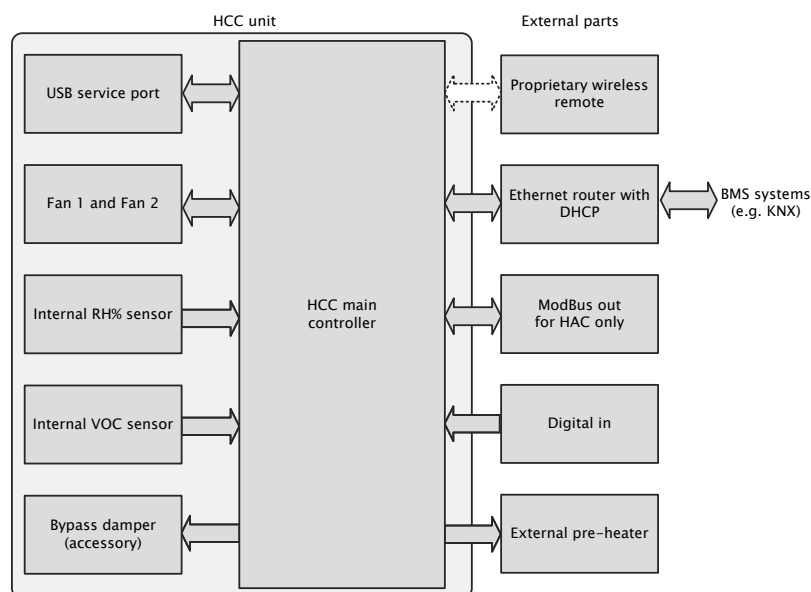

Overall system architecture schematics



Installation

After installation of the unit, ducts and condensate hose, the unit needs to be calibrated to the specific environment.

Measurement of air volumes is done via built in air pressure ports. The initial adjustments are performed through the Dantherm PC-Tool connected to the unit via a USB connection or by means of the wired control (HCP 10).

An air performance graph is adhered to the front cover, showing the pressure and air volumes the installer must use to determine the correct fan speeds. (Label example below.)

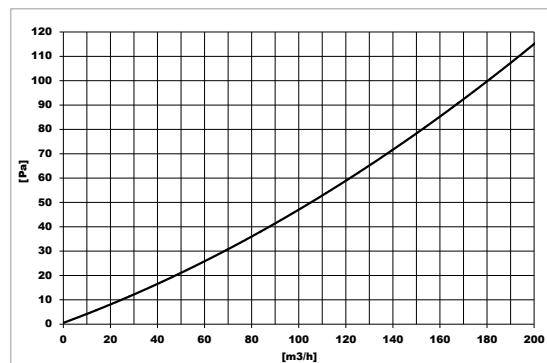

Safety operation - connection to a smoke or fire alarm system

In order to protect the occupants from outside fire or smoke, it is possible to connect a standard smoke/fire alarm system to the HCC 2 home ventilation unit. The smoke/fire detection equipment can be connected to the accessory controller (HAC 2 accessory) at the fire protection terminals. When activated the unit will give a fire alarm signal and stop both fans to avoid more smoke/fire to enter from outside. Once the smoke/fire danger is no longer present the unit must be restarted by power on/off again.

Alternatively, if the user is only interested in avoiding smoke from outside to enter the home (during heating season when fireplaces are in use in the neighbourhood) it is possible to use the digital input connection direct at the unit control to make the unit stop when smoke is detected in the outdoor air intake. When using the digital connection the unit will automatically restart when there is no longer smoke in the outdoor air. Please note: Still, standard smoke detection equipment must be used for the detection of smoke.

In case of higher risk of smoke/fire or higher safety requirements) it is also possible to build duct dampers into the duct work and have the ventilation unit open/close these whenever the unit is running/stopped. The damper motors (one for supply and one for extract air) can be powered and controlled by the HAC 2 accessory controller.

Maintenance

In general, the only regular maintenance required by the HCC home ventilation unit is to check/change the air filters once or twice a year, when the alarm sounds from the unit, or flashes on any connected controls.

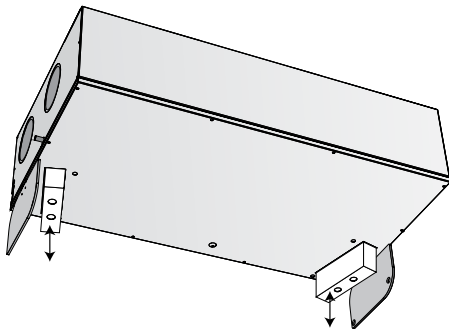

Filter change

The user changes the filter by opening both hinged lids, changing the filters and resetting the filter timer with the wired control (HCP 10) which is an optional extra. If no controls are available filter change needs to be carried out by an installer, with the appropriate PC-tool on his laptop for resetting the filter timer.

Apart from changing the air filters and cleaning the outside of the unit, any other form of service will have to be carried out by qualified personnel. Local Dantherm technicians and Dantherm partners are always available to solve any problem with the unit that might arise.

Any kind of service, user or installer, is done by removing the front cover only.

CONTROL

Control strategies

The installation is always secured against incorrect and uneconomical operation over a longer period. This is because several of the functions return to default after 4 hours. This prevents inconvenient excessive energy consumption if you forget that you have set the unit to full speed or manual bypass. If you switch off the installation it automatically restarts after 4 hours, so you can be sure that your home will be properly ventilated and that condensate will not form in the ducts and in the unit.

The unit is controlled at any time by the installer or by the user. By default the unit is equipped with a USB connection, in order to let the installer do the initial calibration and setup of the unit.

If the user needs interaction to the unit, at least one of the following **accessories** needs to be purchased:

- ▶ Wired control (HCP 10)
- ▶ Wireless remote control (HRC 3)
- ▶ Dantherm PC-Tool

Wired connection from MODBUS out, to a local building management system, can also be used for two way communication.

During initial calibration, fan speed no. 3 is set on the control panel to the nominal air volume that the house requires under normal usage.

The correlation between the four fan speeds on the control panel is as follows:

- ▶ Fan speed 0 = both fans stopped for 4 hours (4 hours timeout).
- ▶ Fan speed 1 = 30 % lower than fan speed 2
- ▶ Fan speed 2 = 30 % lower than fan speed 3
- ▶ Fan speed 3 = Nominal air change, set by installer during the initial calibration.
- ▶ Fan speed 4 = 30% higher than fan speed 3 (4 hours time out)

Filter control

Because backpressure in the filter increase when the filter is dirty, this is compensated for by the two fans running faster and faster, until the filter alarm sounds/lights up and the filter timer is reset.

TECHNICAL DATA

Specification		HCC 2
Max. air flow	m ³ /h	260
Energy consumption class (SEC-class), average climate		A
Energy consumption class (SEC-class), average climate		A+ ¹⁾
Operating range DIBt	m ³ /h	70 to 140
Operating range Passivhaus	m ³ /h	70 to 140
Efficiency DIBt	%	93,8%
Efficiency Passivhaus	%	93%
Efficiency EN 13141-7 (dry)	%	94,1%
Sound power level from cabinet (Passivhaus) 140 m ³ /h @ 100 Pa L _W (A)	dB(A)	43
Sound power level from ducts (Passivhaus) 140 m ³ /h @ 100 Pa Supply/Extract L _W (A)	dB(A)	60/45
Filters according EN 779:2012 (Exhaust/Supply)	Class	G4/G4 (F7 option)
Installation surrounding temperature	°C	+12 to +40
Maximum humidity in extract air @25°C	RH%	65
Outdoor temperature (without preheating installed)	°C	-12 ²⁾ to +50
Outdoor temperature (with preheating installed)	°C	-25 to +50
Enclosure:		
Dimensions WxHxD (without bracket)	mm	600 x 1122 x 279
Duct connections	mm	ø125 - female
Weight	kg	34
Insulation Lambda 0,031	W/(m*K)	U<1
Drainage hose included	ø/length	1/2" – 2m
Cabinet colour	RAL	9016
Fire classification, polystyrene DIN 4102-1	Class	B2
Fire classification, unit according EN 13501-1:2002	Class	E
Electrical:		
Power input (tolerance 10%)	V AC	230
Max. current consumption (without/with preheater)	Watt	127 / 950
Frequency (tolerance 2%)	Hz	50
IP protection class	IP class	20

¹⁾ Requires an optional Energy Efficiency Class A+ kit (including VOC sensor and RH% sensor). Described under Accessories.

²⁾ Preheating is recommended when outside temperatures are below -5°C to ensure balanced operation of the home ventilation unit.

Sound data

Air-volume m ³ /h	Pres. Pa	Measure point	Frequency band sound power L _W (A) dB(A)								Total sound power L _W (A) dB(A)	Sound pres. L _p (A) Standard room*
			63Hz	125Hz	250Hz	500Hz	1000Hz	2000Hz	4000Hz	8000Hz		
80	30	Supply air	23	43	40	42	39	32	20	18	47	
		Extract air	12	26	24	24	16	16	17	18	30	
		Cabinet									30	
98	50	Supply air	28	41	51	48	44	39	26	18	54	
		Extract air	16	27	31	29	19	16	17	18	35	
		Cabinet									34	
100	100	Supply air	32	49	56	52	49	44	33	19	59	
		Extract air	19	31	42	33	23	19	17	18	43	
		Cabinet									37	
126	70	Supply air	31	43	55	52	49	45	33	19	58	
		Extract air	19	30	42	33	23	19	17	18	42	
		Exhaust air	30	43	54	52	47	43	32	18	57	
		Cabinet									40	
140	100	Supply air	34	46	56	56	52	49	37	21	60	
		Extract air	21	33	44	36	27	21	18	18	45	
		Exhaust air	33	45	56	56	51	47	36	20	60	
		Cabinet									43	
162	80	Supply air										
		Extract air										
		Cabinet									46	
198	90	Supply air										
		Extract air										
		Cabinet									48	

* Standard room = room with 10m² floor, 2,4 m ceiling height, mean absorption 0,2.

Enclosure dimensions

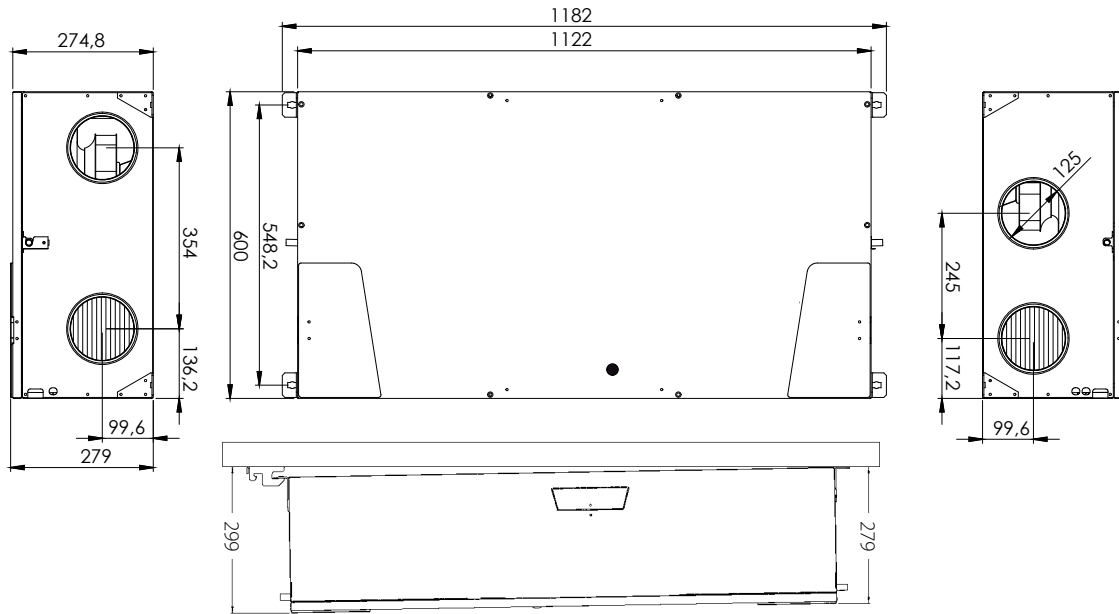

Duct connections

Illustration of duct connections in fan direction **mode A:**

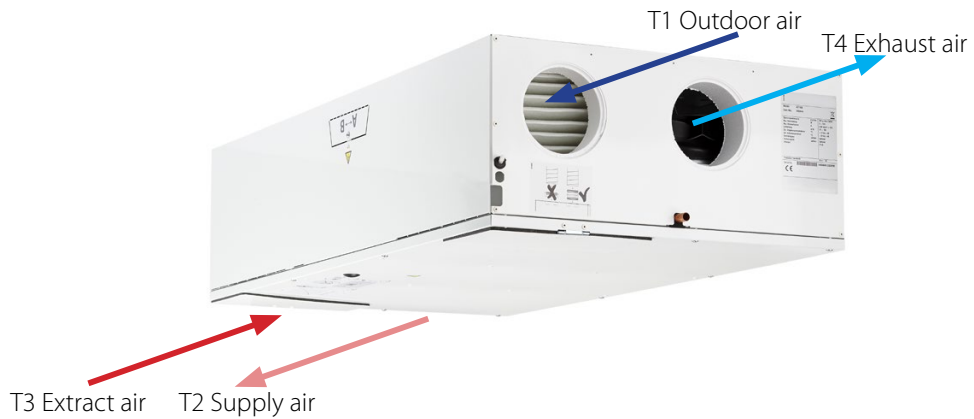
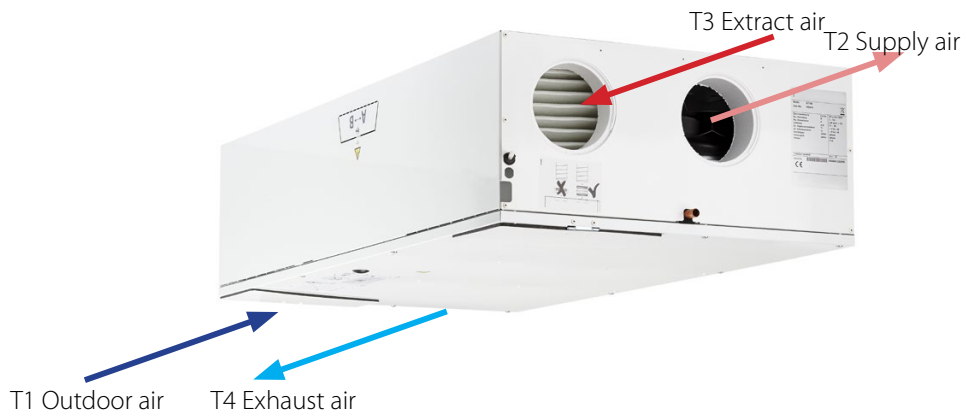
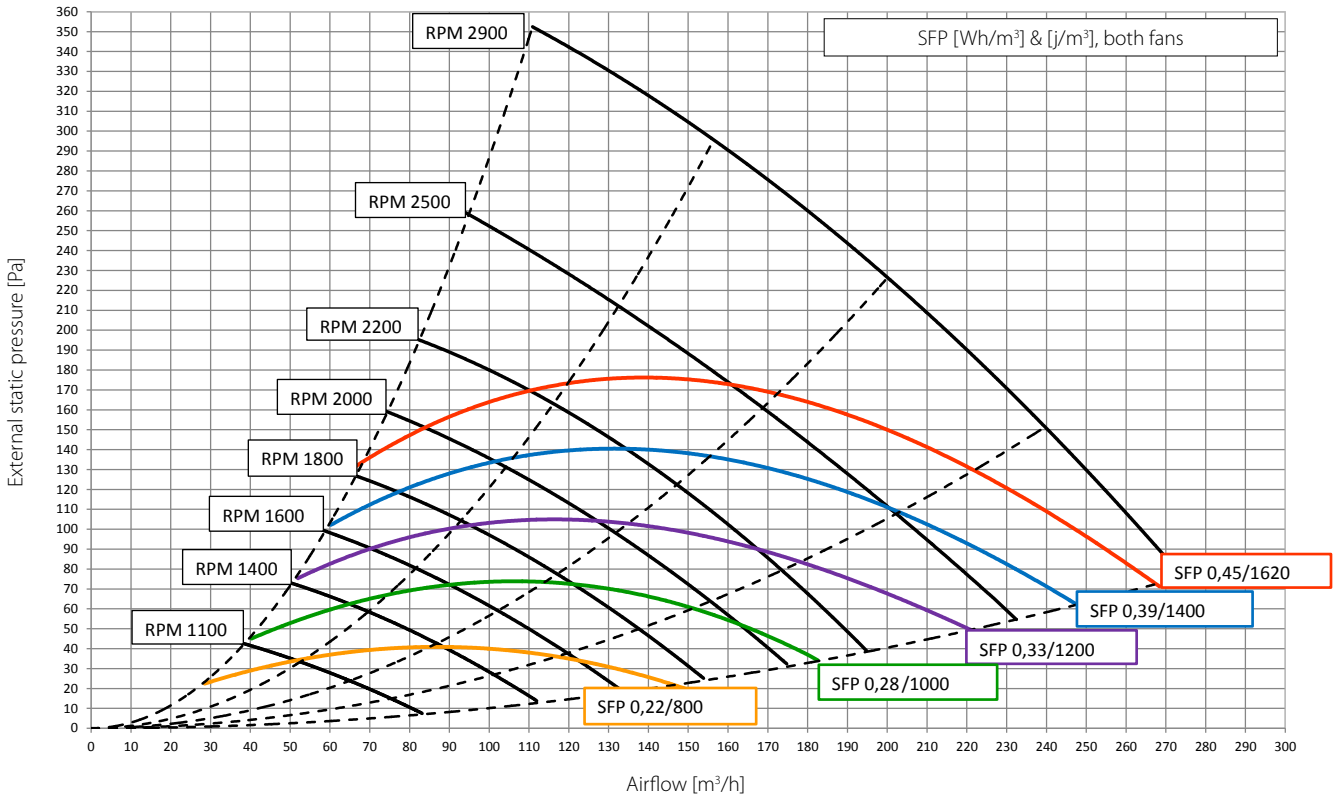

Illustration of duct connections in fan direction **mode B:**



Capacity and SFP curves



Temperature efficiency

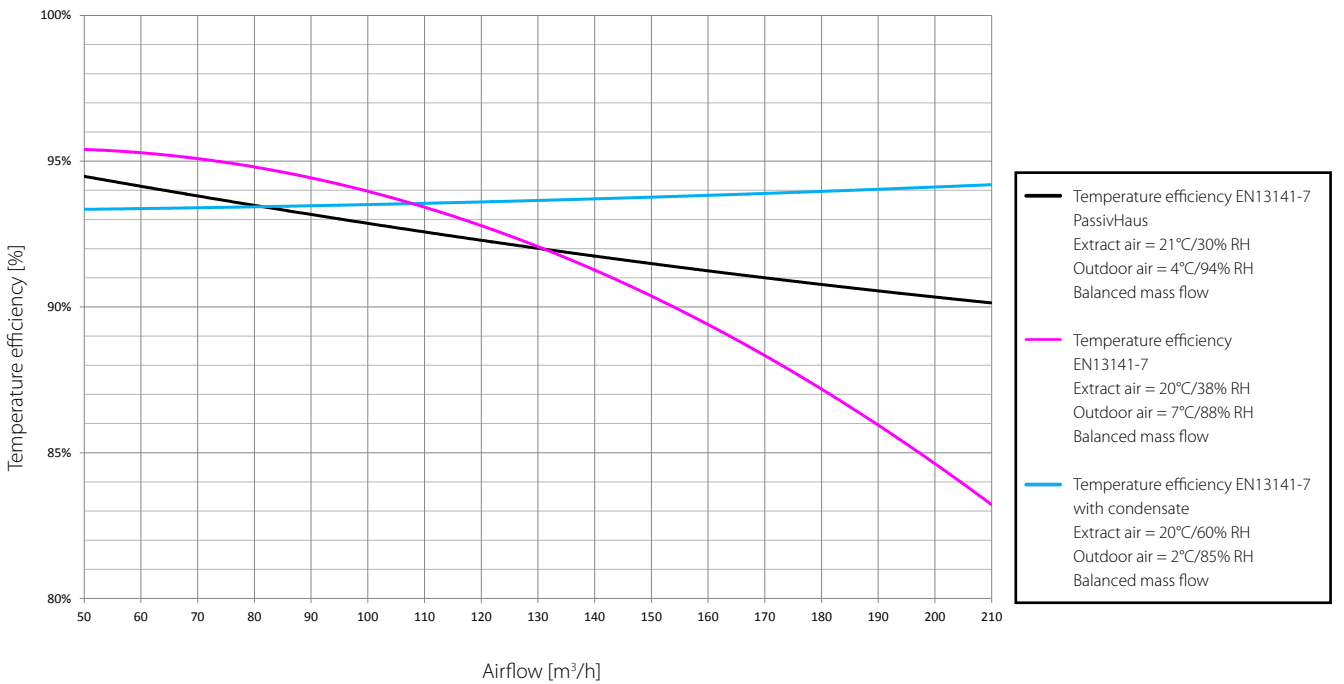



Wired control

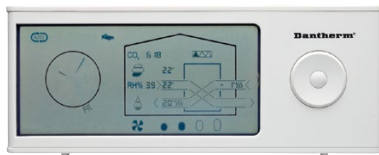

Wireless remote control

ACCESSORIES

Wired control (HCP 10)

Dantherm offers a prewired control unit, which is connected to the ventilation unit with a 6 m cable. The wired control comes with a white plastic frame and a metal frame for fastening into a standard junction box. Alternatively Dantherm can supply a box for fixing to the wall in an appropriate place.

The HCP 10 wired control gives the user the following possibilities :

- ▶ Manual control of air change (step 0-4)
- ▶ Control of air change with week program
- ▶ Demand controlled air change (if RH and VOC sensors are connected)
- ▶ Enable summer mode (only extract air)
- ▶ Enable manual bypass (requires an optional mechanical bypass to be mounted)
- ▶ Enable fireplace mode
- ▶ Reading and resetting of alarms, including filter alarm.

The wired HCP 10 control offers the possibility of adjusting the air volumes without using Dantherm's PC Tool.

Wireless remote control (HRC 3)

Dantherm offers a wireless remote control, which can be mounted on the wall or placed on a shelf. The remote control is designed for the user, but also includes a special installer menu, allowing the installer to do extensive settings, without the use of the PC Tool.

The remote control has an acoustic alarm that will sound when the filters need to be inspected or replaced. This insures correct maintenance even when the HCC 2 unit is set to demand mode, and regular attention is not towards the remote control.

The user features are:

- ▶ Fan speed in manual mode.
- ▶ Select demand mode (requires RH and/or VOC sensors to be mounted)
- ▶ Select week mode and week program 1-11.
- ▶ Manually open bypass. It closes again automatically.
- ▶ Enable fireplace boost mode. 7 minutes with overpressure inside the house for easy ignition of a fireplace.
- ▶ Enable away mode in which the unit decreases permanently to speed 1
- ▶ Enable night mode in which the unit decreases to speed 1. The time night mode can be adjusted.
- ▶ Remaining filter period + adjustment of same.
- ▶ Reading of temperatures in all four duct connections, including the remote control's embedded temperature sensor, as well as relative humidity and quality of the extract air (accessory).
- ▶ Setting time and date.



External electrical preheating coil

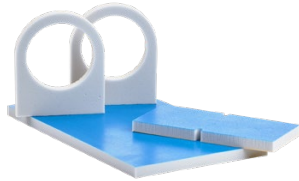

Pre-heat insulation kit



Mechanic bypass module



RH% demand sensor



VOC air quality demand sensor



Digital plug

External electrical preheating coil, 900 W

The electrical heating coil prevents ice building up in the heat exchanger at low temperatures. The heating coil is mounted in the outdoor air duct. The heating coil is connected to and controlled by the HCC 2 controller, which adjusts the heat output so as to ensure an ice-free heat exchanger with the lowest possible energy consumption.

Pre-heat insulation kit for HCC 2

This insulation kit is designed for fixing to the HCC 2 preheater. This customized insulation kit protects against thermal bridges, condensation and excessive energy consumption.

Mechanic bypass module

The HCC 2 home ventilation unit can be fitted with an automatically controlled bypass damper module, that exploits the colder outdoor air to cool down the home, e.g. after a hot summer's day, when the outdoor night time temperature falls below the temperature of the house. The bypass module leads all the hot exhaust air past the heat exchanger in order to achieve the best possible cooling effect.

RH% demand sensor (included in the Energy Efficiency Class A+ kit)

The HCC 2 home ventilation unit can be fitted with a humidity sensor (RH%). This sensor will continuously monitor the humidity of the extract air and adjust the air flow level accordingly. This operation is named demand mode. If a wireless remote control is connected, the level will be shown in the display using a 3 level icon. Using demand mode will result in the correct level of ventilation with lowest possible electrical power consumption. If both VOC and RH% sensors are fitted, the ventilation level is set by the highest demand from just any one of the sensors.

VOC air quality demand sensor (included in the Energy Efficiency Class A+ kit)

The HCC 2 unit can be fitted with a VOC air quality sensor. This sensor will continuously monitor the level of artificial as well as natural organic fumes in the air. Examples of included fumes:

- ▶ Natural fumes, e.g. formaldehyde from building materials.
- ▶ Chemical fumes from sprays, e.g. hair spray or perfumes.
- ▶ Indoor pollution e.g. from smoking and printing with laser printer.
- ▶ Fumes from fire retardant substances in carpets, paint and furniture.

Using the VOC sensor in demand mode will result in the correct level of ventilation with lowest possible electrical power consumption. If a wireless remote control is connected, the actual VOC level will be shown in the display using a 3 level icon.

Digital plug (bag with 25 pcs.)

This digital plug is connected to the control of the HCC 2 unit. This allows to override the following :

- ▶ Fan speed 0, 1, 2, 3, 4
- ▶ Fire/smoke/negative pressure /stop + alarm
- ▶ High water level stop + alarm



Condensate pump kit



Hygrostat, Sauter HSC 120 F001



Accessory control HAC 2



Power supply 230VAC - 24VDC



CO2 sensor



USB cable, 3 m



Calibration set



PC Tool Kit

Condensate pump kit

This condensate pump kit is designed for mounting on HCC 2 units where there is no safe drain with fall to a drainage or on units where the drain is too far away (more than 5 m horizontal way). The kit is furnished with a bracket for fixing it to the HCC 2 unit, a power supply cable for connection to the HCC 2 unit, pressure equalization hose and drain hose.

Hygrostat, Sauter HSC 120 F001

The hygrostat is connected to the accessory control in case that a higher air change rate is required in rooms with high humidity.

Accessory control HAC 2

One or more of the following functions can be connected to the accessory control:

- ▶ After heating coils for water or electricity
- ▶ Geothermal preheating/precooling coils
- ▶ 24 VDC duct damper outlet
- ▶ Stop function inlet
- ▶ Fire/smoke detector inlet
- ▶ External CO2 sensor for demand control
- ▶ External hygrostat
- ▶ Filter alarm outlet
- ▶ General alarm

HAC 2 comes with 3 m cable.

Power supply 230VAC – 24VDC, for duct control

Power supply to be mounted in the accessory control if the ventilation unit controls a duct damper.

CO2 sensor

The CO2 sensor is connected to the accessory control if the air change has to be controlled in accordance with the CO2 level in a given room.

USB cable, 3 m

USB cable to be used in connection with software update of HCC 2 and Dantherm PC Tool (HPT 1).

Calibration set (bag with 10 sets)

This calibration kit contains 10 sets with each 3 m hose, two suction cups with hook and two nipples. The kit is used for adjusting the HCC 2 air flows.

Dantherm PC Tool Kit (HPT 1)

The PC Tool Kit contains a USB plug with program and quick guide + USB cable. The Dantherm PC Tool has an installer menu, where the installer can adjust the HCC 2 unit, connect extra accessories, adjust various user settings, read and reset alarms, if any. It also has a user menu, where the user can read and adjust various settings, such as week programs, set points, alarms and historical data about temperatures and air quality (accessory).

ELECTRONICS COOLING

DEHUMIDIFICATION

VENTILATION

MOBILE HEATING AND COOLING

Dantherm is a market-leading supplier of energy-efficient climate control solutions for customers across the globe. Our subsidiaries in Norway, Sweden, Germany, and the UK and our representative office in Russia unite approx. 240 employees. We operate in the following four main business areas:

Electronics cooling:

Climate control for electronics and battery cooling in radio base stations and other Telecom infrastructure. Telecom customers include network suppliers and network operators.

Dehumidification:

Mobile and stationary dehumidifiers for drying buildings and for use in private pools and wellness centres.

Ventilation:

Large ventilation systems used in swimming pools and buildings such as shopping centres and cinemas requiring frequent air change. The range also includes domestic ventilation products based on high-performance heat exchangers.

Mobile heating and cooling:

Products for heating or cooling of tents and equipment used by the armed forces and aid organisations. The customers are primarily the armed forces in NATO countries as well as tent and container manufacturers.

Dantherm Air Handling A/S

Marienlystvej 65
DK-7800 Skive, Denmark
Tel. +45 96 14 37 00
Fax +45 96 14 38 20
info@dantherm.com
www.dantherm.com

